

# HYDRA RAM<sup>®</sup>

ADVANCED DEMOLITION EQUIPMENT



**HSB SERIES**



**11 MODELLE VON 250 BIS 2550KG  
FÜR BAGGER VON 3 ~ 40 TONNEN**







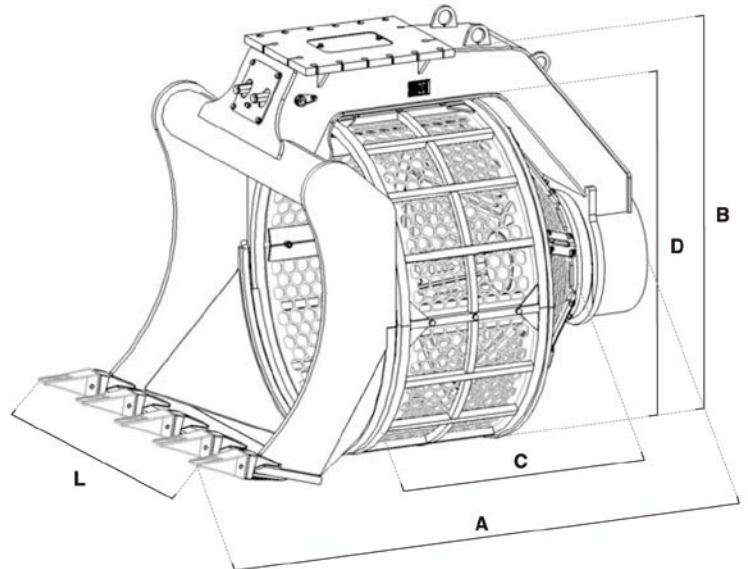

# HYDRA RAM®

ADVANCED DEMOLITION EQUIPMENT

## HSB SERIES



		HSB-300	HSB-400	HSB-700	HSB-1400	HSB-1400S	HSB-1600	HSB-1600S	HSB-1900	HSB-1900S	HSB-2600	HSB-2600S
 (1)	t.	3:5	5:8	8:12	13:16	13:16	17:21	17:21	22:30	22:30	31:40	31:40
 *	kg.	250	350	690	1320	1320	1570	1570	1810	1810	2550	2550
A	mm.	1070	1175	1480	1950	1950	2190	2190	2250	2250	2600	2600
B	mm.	805	930	1055	1460	1460	1650	1650	1890	1890	2000	2000
C	mm.	445	515	690	790	790	925	925	980	980	1040	1040
D	mm.	640	750	840	1170	1170	1340	1340	1560	1560	1700	1700
L	mm.	700	800	900	1200	1200	1400	1400	1600	1600	1750	1750
Cap. SAE	m <sup>3</sup>	0,2	0,3	0,4	0,75	0,75	0,9	0,9	1,1	1,1	1,5	1,5
 	bar	100 / 120	100 / 120	100 / 120	100 / 120	150 / 200	100 / 120	150 / 200	100 / 120	150 / 200	100 / 120	150 / 200
 	l/min.	30 / 50	30 / 50	50 / 70	80 / 100	100	80 / 100	100	80 / 100	100	80 / 100	100
	rpm	18 / 24	18 / 24	18 / 24	18 / 24	35 / 40	18 / 24	35 / 40	18 / 24	35 / 40	18 / 24	35 / 40
Lecköl-Leitung		/	/	/	/	✓	/	✓	/	✓	/	✓

(\*) Die oben genannten Gewichte beinhalten nicht die Bagger Anbauplatte.  
 (1) Empfohlene Bagger/Anbauteil Kombination.

(DEALER)



**HYDRA  RAM®**  
 ADVANCED DEMOLITION EQUIPMENT

**HYDRARAM b.v.**  
 Meander 7  
 NL 9231DB SURHUISTERVEEN  
 The Netherlands

tel. +31 512-365981  
 fax. +31 512-365761  
 www.hydraram.com  
 info@hydraram.com