

HYDRA RAM[®]

ADVANCED DEMOLITION EQUIPMENT

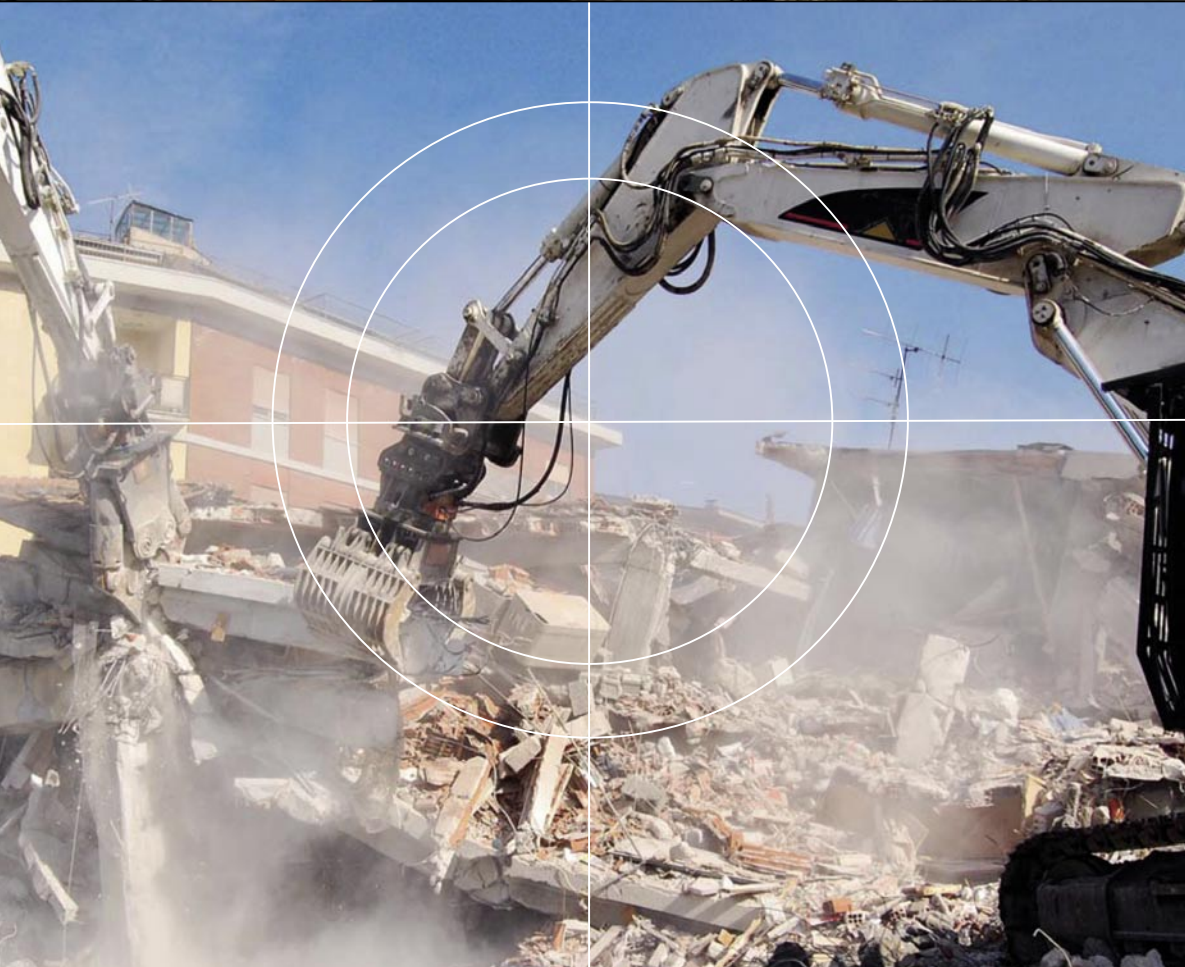

HSG-N SERIES



**11 MODELLE ABBRUCH & SORTIERGREIFER VON 75 BIS 3870 KG
FÜR BAGGER VON 1 ~ 65 TONNEN**







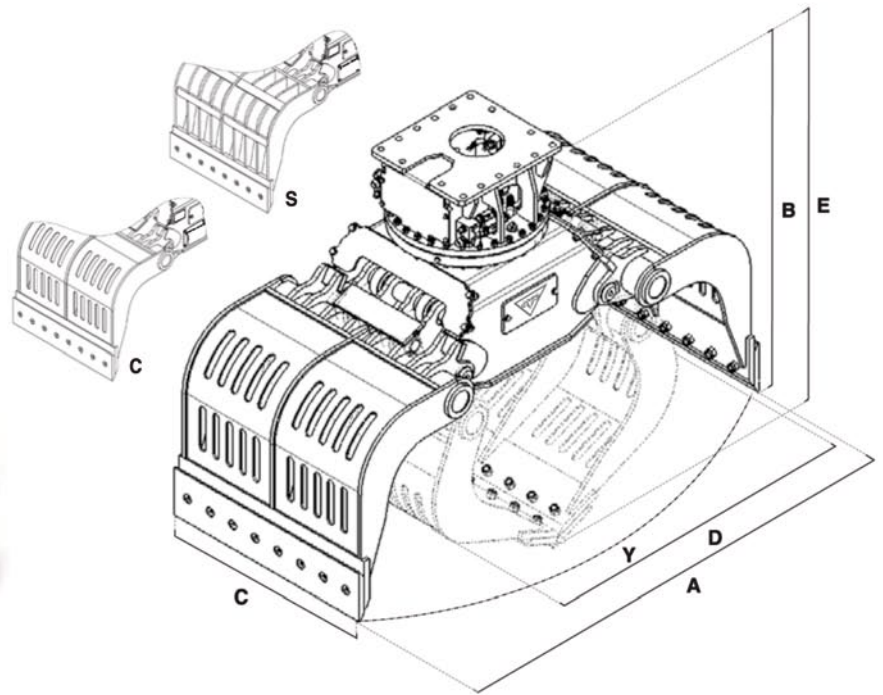

HYDRA RAM®

ADVANCED DEMOLITION EQUIPMENT

HSG-N SERIES



		HSG-1N	HSG-2N	HSG-3N	HSG-4N	HSG-5N	HSG-9N	HSG-12N	HSG-16N	HSG-20N	HSG-30N	HSG-40N
 ⁽¹⁾	t.	0,6 : 1	1 : 2,5	2,5 : 4	4 : 6	6 : 8	9 : 14	15 : 19	20 : 25	23 : 30	31 : 45	46 : 65
 *	kg.	75	140	200	370	420	750	1070	1530	1995	3160	3870
A	mm.	600	750	1150	1100	1490	1750	1950	2060	2455	2800	3050
B	mm.	600	750	1150	930	990	1170	1290	1410	1555	1800	2100
C	mm.	300	450	500	600	600	700	900	1000	1150	1300	1500
D	mm.	430	630	730	760	910	1050	1180	1260	1450	1700	1950
E	mm.	600	820	945	1010	1210	1320	1460	1580	1790	2020	2300
Y	t.	0,5	1,3	1,7	2	2,5	3,5	5	6	9	12,5	15
 N°		1	1	1	1	1	2	2	2	2	2	2
Cap. SAE	m ³	0,03	0,07	0,1	0,2	0,4	0,5	0,7	0,9	1,2	1,5	1,8
	bar	250	250	250	250	250	310	310	310	310	310	310
	l/min.	15 / 20	25 / 30	35 / 40	80 / 100	80 / 100	80 / 100	80 / 100	80 / 100	100 / 120	100 / 120	120 / 150
 max	bar	120	120	120	120	120	140	140	140	140	140	140
 max	l/min.	5	10	10	10	10	10	10	10	10	10	20

(1) Empfohlene Bagger/Anbauteil Kombination.

(*) Die oben genannten Gewichte beinhalten nicht die Bagger Anbauplatte

(DEALER)



HYDRA  RAM®
ADVANCED DEMOLITION EQUIPMENT

HYDRARAM b.v.
Meander 7
NL 9231DB SURHUISTERVEEN
The Netherlands

tel. +31 512-365981
fax. +31 512-365761
www.hydraram.com
info@hydraram.com

*SPECIFICATIONS IN THIS BROCHURE ARE SUBJECT TO CHANGE WITHOUT NOTICE